



METALUSA

METALUSA PRODUCTS

SCAFFOLDING SYSTEM

MULTIDIRECTIONAL SCAFFOLD

ADAPT® - MULTIDIRECTIONAL SCAFFOLD



CERTIFICATIONS

3D VIDEO

SPECIAL SOLUTIONS

ADAPT® - BLEACHERS



COMPLIANCE WITH:

- EN 13200-5;
- EN 13200-6;
- Eurocódigo 0;
- Eurocódigo 1;
- Eurocódigo 3;
- EN 12727;
- EN-12810;
- EN-12811;



3D

ALUSTA® - STAGES

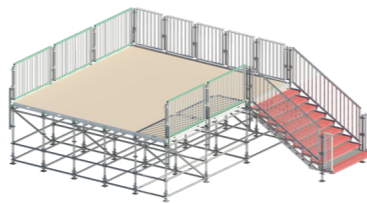

COMPLIANCE WITH:

- UNE 180201;
- Eurocode 9;
- NF X 35-109;
- UNE-EN 131;
- UNE-EN 1065;
- UNE-EN 1990;
- UNE-EN 1991;
- UNE-EN 1993;
- UNE-EN 1995;
- UNE-EN 1999;
- UNE-EN ISO 14122-4;



3D

ADAPT® - TRADITIONAL STAGES

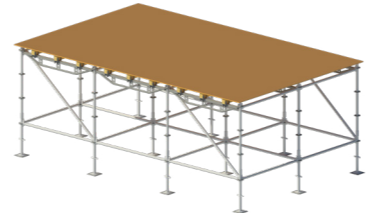

SHORING

ADAPT® - ADAPT® SHORING TOWER.



ADAPT®

3D

ADAPT® - HD200 SHORING TOWER





ADAPT®

3D

COVERINGS

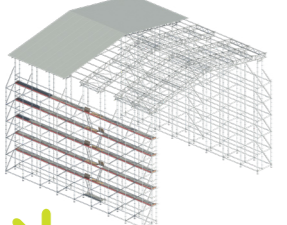
ADAPT® - STEEL COVERING.



ADAPT®

3D

ALUCOVE® - ALUMINIUM COVERING.



ALUCOVE®

3D

ACCESS

ROSTEP®.



COMPLIANCE WITH:

- NF P93-521;



ROSTEP®

3D

PUBLIC ACCESS STAIRS



COMPLIANCE WITH:

- NF P93-523;



ADAPT®

3D

INDUSTRIAL ACCESS STAIRS



COMPLIANCE WITH:

- NF P93-522;



ADAPT®

3D

TOWERS

INDUSTRIAL TOWERS WITH OR WITHOUT WHEELS.



ADAPT®

ACCESS TOWERS 4 FEET AND 8 FEET.

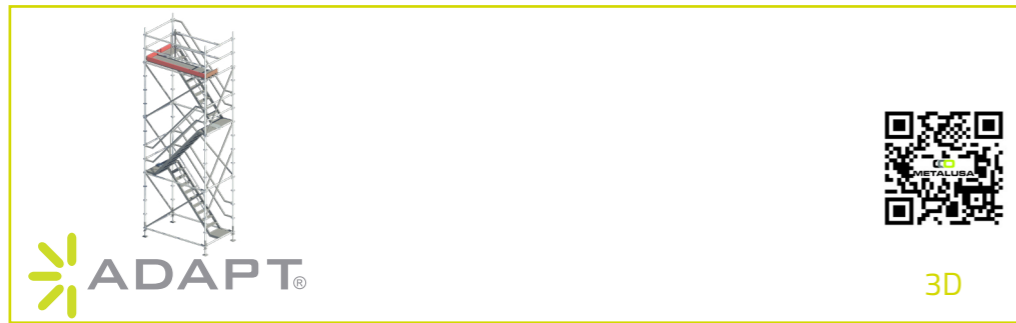

FACADE SCAFFOLD

NOR48® - FACADE SCAFFOLD.



VERTICAL FORMWORK SYSTEM

FORTEKO® - VERTICAL FORMWORK.



FORTEKO® - COLUMN FORMWORK.



MODUTEC® - VERTICAL FORMWORK.



MODUTEC® - COLUMN FORMWORK.



UPFORM® - VERTICAL FORMWORK.



ROFLEX® - CIRCULAR VERTICAL FORMWORK.



PILCO® - ROUND COLUMN FORMWORK.



BLOCTEK® - FORMWORK BUTTRESSES.



HORIZONTAL FORMWORK SYSTEM

COFIBER® - FLAT FORMWORK.

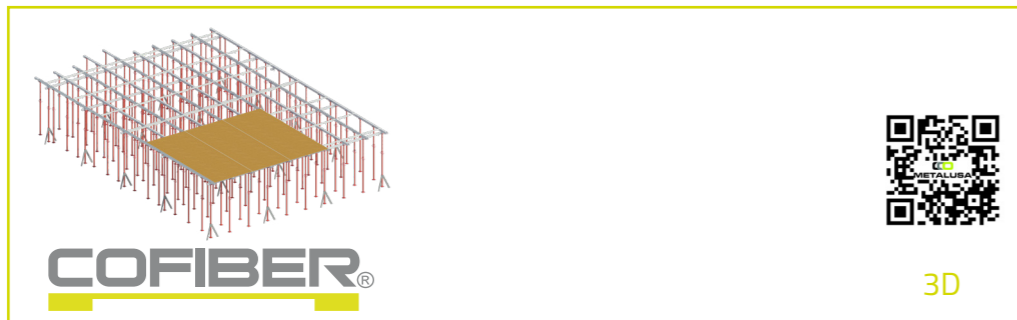

UPFORM® - FLAT FORMWORK TABLES.

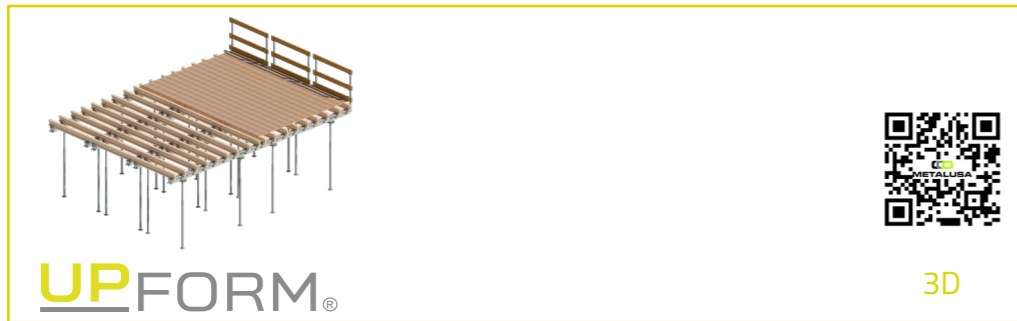

ALUFOX® - FLAT SLAB FORMWORK SYSTEM.

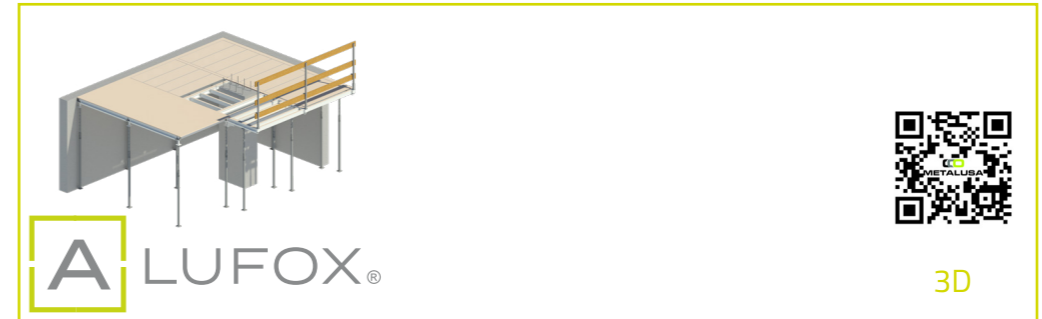

SHORING SYSTEMS

TOWROK® - SHORING TOWERS.



SHORFLEX LT® - HIGH RESISTANCE SHORING.



SHORFLEX HD® - HD HIGH RESISTANCE SHORING.

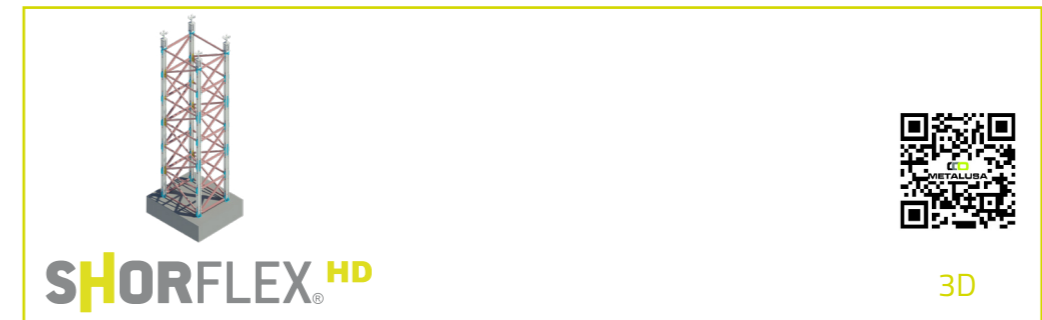

ENGINEERING STRUCTURES

SHORFLEX LT® - FACADE STABILIZER.

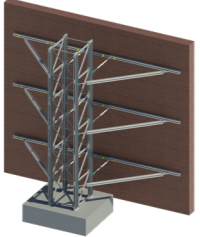

SHORFLEX^{LT} 3D

SHORFLEX HD® - FACADE STABILIZER.



SHORFLEX^{HD} 3D

ENTIBACIÓN DE ZANJAS

TIVATEC® - TRENCH SHORING SYSTEM.



TIVATEC[®] CERTIFICATIONS 3D

SUSPENDED PLATFORMS

SAFTEC® - WORK AND SAFETY PLATFORMS.

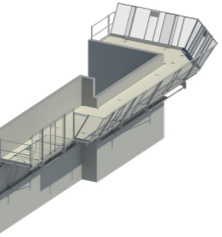

SAFTEC[®] 3D

STORAGE SYSTEMS

DUPAL® - OPEN PALLET.

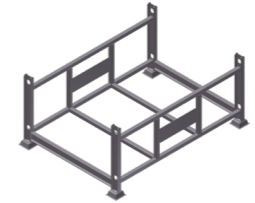

DUPAL

DUPAL® - CLOSED PALLET.



DUPAL

DUPAL® - DEMOUNTABLE PALLET.



DUPAL

